

Installation Guide Rail Kit for Easy UPS On-Line Rack-mount Series

Important Safety Information

Read the instructions carefully and look at the equipment to become familiar with the device before trying to install, operate, service or maintain it. The following special messages may appear throughout this document or on the equipment to warn of potential hazards or to call attention to information that clarifies or simplifies a procedure.



The addition of this symbol to a Danger or Warning product safety label indicates that an electrical hazard exists that will result in personal injury if the instructions are not followed.



This is the safety alert symbol. It is used to alert you to potential personal injury hazards. Obey all safety messages that follow this symbol to avoid possible injury or death.

⚠ DANGER

DANGER indicates a hazardous situation which, if not avoided, **will result in** death or serious injury.

⚠ WARNING

WARNING indicates a hazardous situation which, if not avoided, **could result in** death or serious injury.

⚠ CAUTION

CAUTION indicates a hazardous situation which, if not avoided, **could result in** minor or moderate injury.

NOTICE

NOTICE is used to address practices not related to physical injury.

Product Description

These rail kits are ideal for mounting rack Easy UPS in a rack. These rail kits can support equipment measuring up to 16.75" (43cm) to 17.7" (45cm) wide. SRVSRK1 can support equipment with a maximum weight of 60kg and SRVSRK2 can support up to 100kg.

Package Contents

The packaging is recyclable; save it for reuse or dispose of it properly.

SRVSRK1

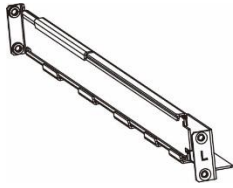

(1)
Left rail slider

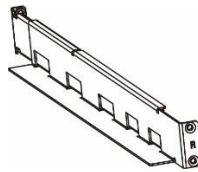

(1)
Right rail slider



(1)
User manual

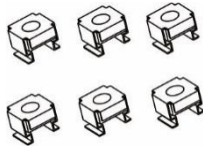

(6)
Cage nut



(4)
Fixing stud



(8)
M6 Screws

SRVSRK2

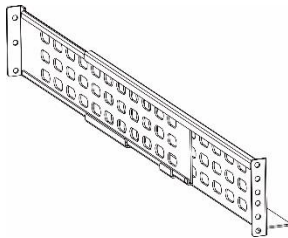

(1)
Left rail slider

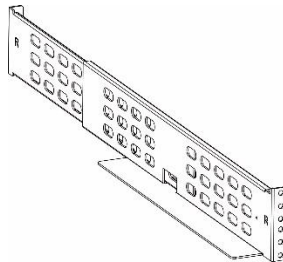

(1)
Right rail slider



(1)
User manual

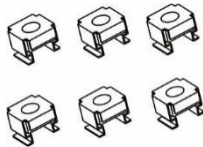

(6)
Cage nut

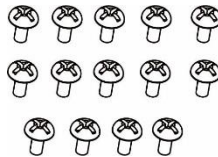

(14)
M6 Screws

Installation

Install SRVSRK1

Please follow below steps to install SRVSRK1.

1. Insert 4 pieces of fixing nuts into the following locations of rail sliders. Be sure fix them firmly. Then, pull apart two ends of rail sliders and place them in a chassis. Be sure the pulling distance meets the depth of rack chassis and place fixing studs to the corresponding holes on supporting columns. For example, if depth of rack chassis is 700mm, please pull the length of rail sliders is 700mm.

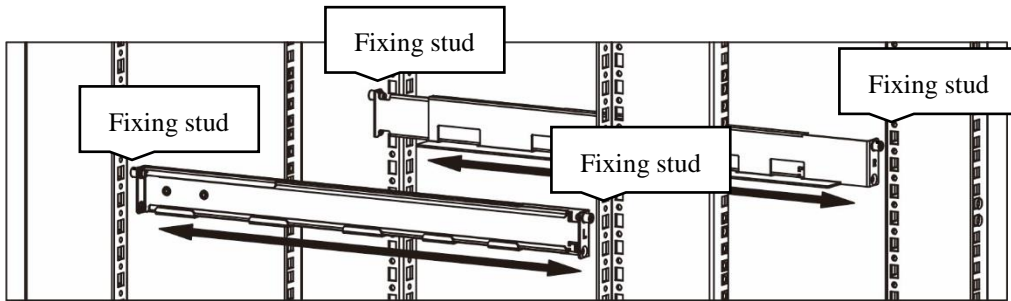

2. Use 4 pieces of M6 screws to mount rail sliders into chassis. See below chart.

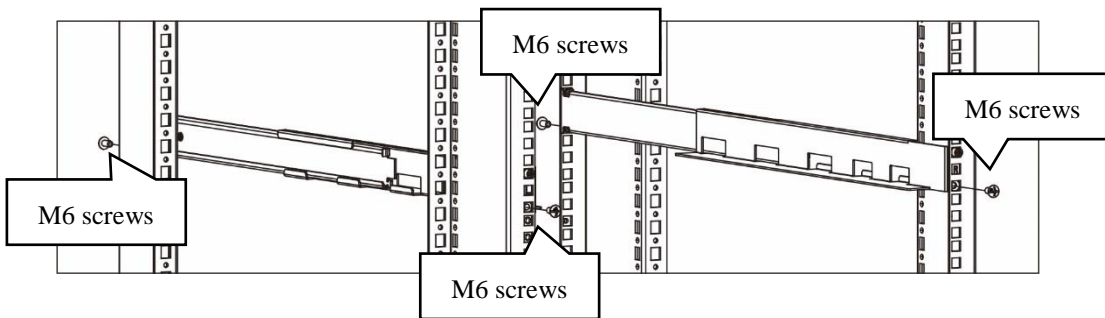

3. According to UPS height, put 6 pieces of nuts on proper location.

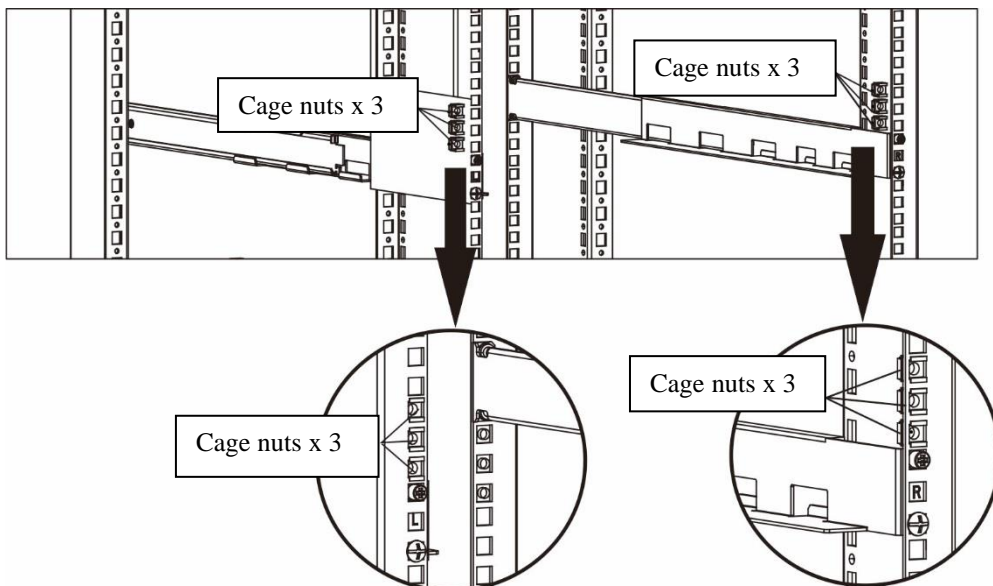

- Put UPS with assembled ears on the rail support.

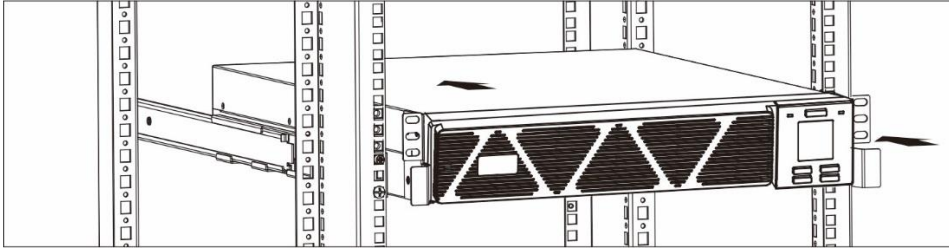

- Fix the UPS in position with 4 screws.

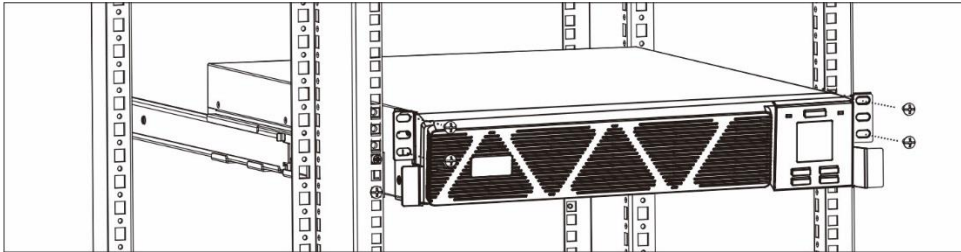

- Assembly is complete.

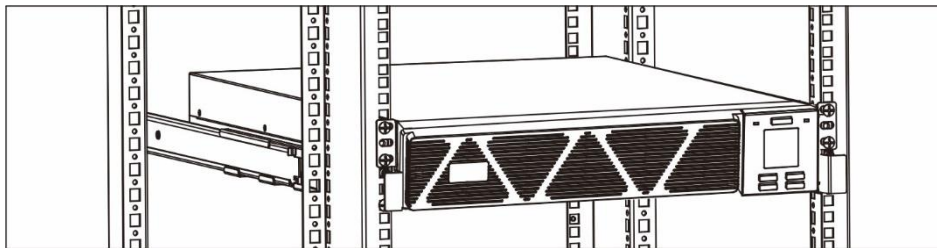

Install SRVSRK2

Please follow below steps to install SRVSRK2.

- Use 4 screws to mount right and left rail sliders in front. See below chart.

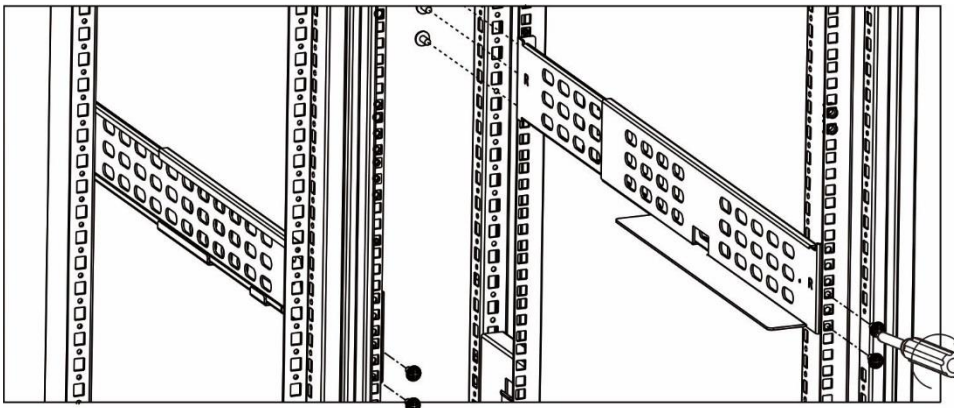

2. Use 4 screws to mount rail sliders in back. See below chart.

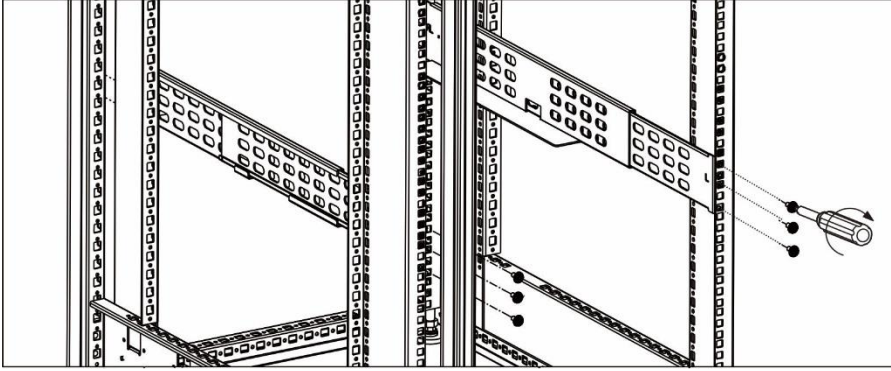

3. According to UPS height, put nuts on proper location.

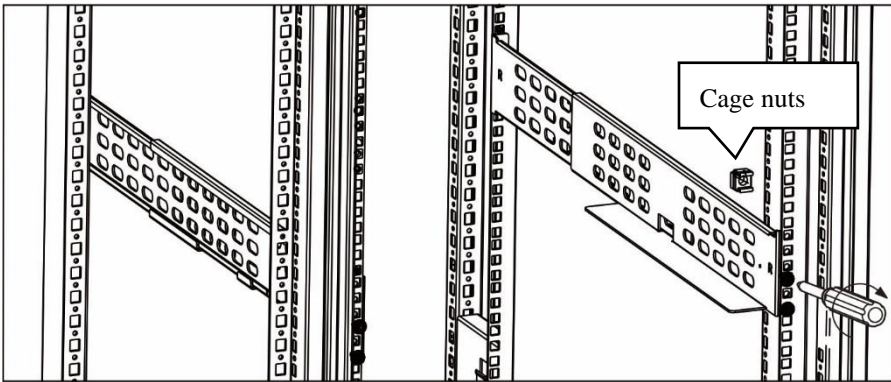

4. Put UPS on the rail support and fix the UPS in position with screws.

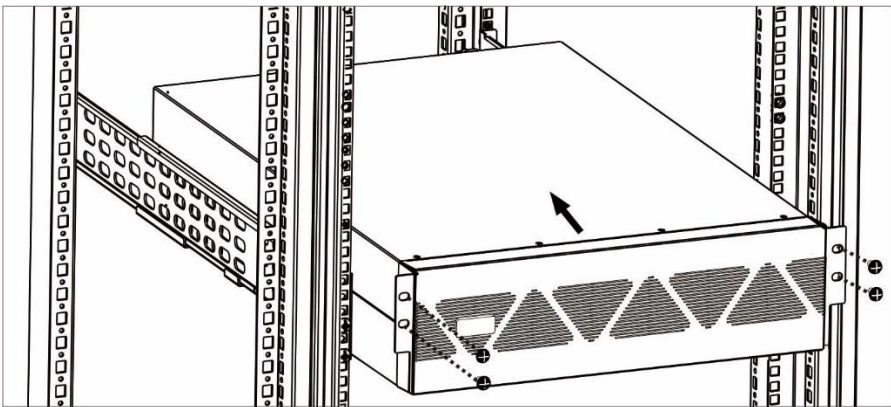

5. Assembly is complete.

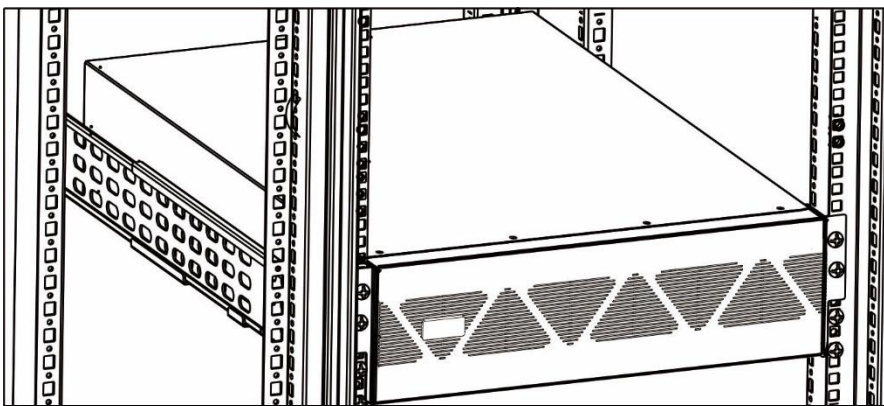

Schneider Electric Worldwide Customer Support

Customer support for this or any other Schneider Electric product is available at no charge in any of the following ways:

- Visit the Schneider Electric website to access documents in the Schneider Electric Knowledge Base and to submit customer support requests.
 - **www.apc.com** (Corporate Headquarters)
Connect to localized Schneider Electric websites for specific countries, each of which provides customer support information.
 - **www.apc.com/support/**
Global support searching Schneider Electric Knowledge Base and using e-support.
- Contact the Schneider Electric Customer Support Center by telephone or e-mail.
 - Local, country specific centers: go to **www.apc.com/support/contact** for contact information.

For information on how to obtain local customer support, contact the Schneider Electric representative or other distributor from whom you purchased your Schneider Electric product.